

# Assembly Instructions

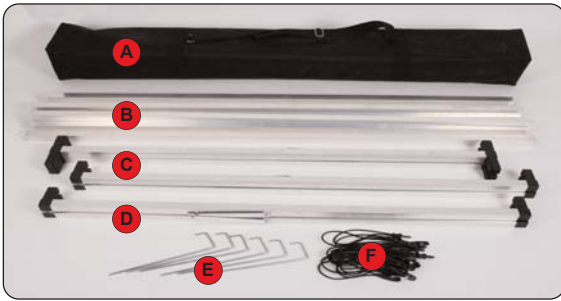

## Kit Includes:

Carry bag (A) Horizontal tube x8 (B)  
Centre 'A' frame x1 (C) End 'A' frame x 2 (D)  
Ground peg x6 (E) and Elastic bungee cord x24 (F)

## Frame assembly



Open up all the End and Centre 'A' frames

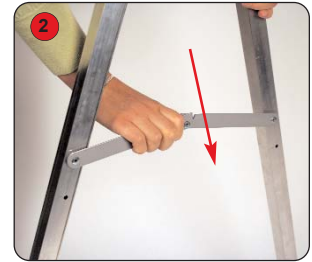

Push each locking arm down to secure the frame

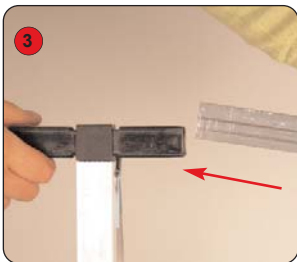

Push fit the top horizontal tubes into the 'A' frames, ensure the plastic joiners face inwards

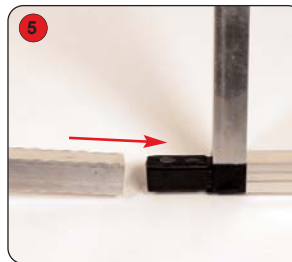
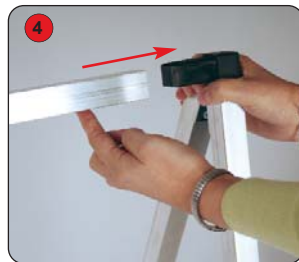

Push fit the bottom horizontal tubes into the 'A' frames, ensure the plastic joiners face inwards

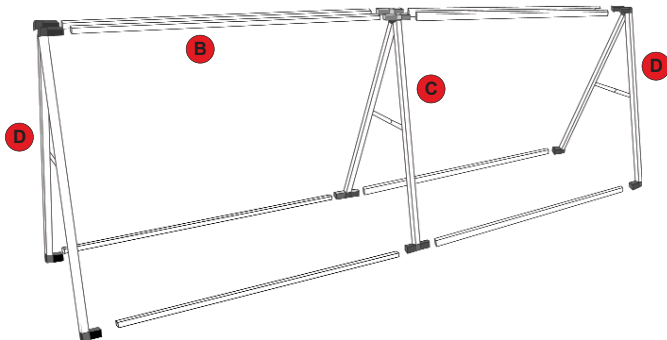

## Graphic attachment



Pass the elastic bungee cord through the graphic eyelet and around the frame to secure

Corner eyelets require a bungee cord loop around the top and the side of the frame to secure

## Ground peg fixing

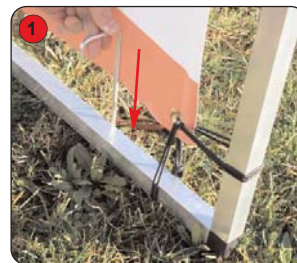

To secure the frame to grassed areas, push or hammer the ground peg into the ground



Ensure the ground peg covers the horizontal tube